



## GIRO Keypad (GIRO TA)

# Operating Instructions

Content	Page
General Description .....	2
Technical Specifications / Safety Precautions / Care and Maintenance .....	3
Functional Description .....	3
System components and package contents .....	4
Dimensions.....	5
Change direction of rotating .....	6
Mounting on wood / Mounting on metal surfaces .....	7
Assembly instructions for the status indicator / Mounting GIRO with the status indicator on wood / Mounting GIRO with the status indicator on metal.....	8
Emergency opening with service key / Getting started and changing batteries .....	9
Structure of the keypad / Factory Settings.....	10
Locking & unlocking in Free Code mode / Switching to Fixed Code mode .....	11
Locking and unlocking in Fixed Code mode / User changes the Fixed Code .....	12
Switching to Free Code Mode .....	13
Changing the Master Code.....	14
Changing the emergency opening code.....	15
Emergency Opening / Resett to Factory Settings .....	16
Automatic locking in Fixed Code mode .....	17
Automatic opening in Free Code mode .....	18
Activation and deactivation of acoustic signals.....	19
Configuration of the lock with the NFC-App .....	20
Battery warning / Update of firmware / Disposal .....	22

## GENERAL DESCRIPTION

The GIRO TA lock is a battery-operated electronic furniture lock with a keypad, which is intended for the inside of buildings. These operating instructions provide you with information on how to operate the locking system without errors. Keep the operating instructions in an easily accessible place. Improper use can destroy the locking system and lead to the loss of any warranty claims.

Please be sure to observe all warnings and read the operating instructions completely before proceeding with installation, commissioning and programming. It may be possible to use our locks and locking systems together with mechanisms made by other manufacturers, but their compatibility must be checked in each individual case. We cannot accept any liability for damage or loss due to incompatibility.

Wording and graphics have been prepared with care. However, no liability will be assumed for any mistakes that may have occurred. Technical specifications as well as the scope of items in the system are subject to change without notice.

### FCC Compliance Statement

This device complies with part 15 of the FCC Rules. Operation is subject to the following two conditions: (1) This device may not cause harmful interference, and (2) this device must accept any interference received, including interference that may cause undesired operation.

#### Caution!

Changes or modifications not expressly approved by the party responsible for compliance could void the user's authority to operate the equipment.

Note: This equipment has been tested and found to comply with the limits for a Class B digital device, pursuant to part 15 of the FCC Rules. These limits are designed to provide reasonable protection against harmful interference in a residential installation.

This equipment generates, uses and can radiate radio frequency energy and, if not installed and used in accordance with the instructions, may cause harmful interference to radio communications. However, there is no guarantee that interference will not occur in a particular installation. If this equipment does cause harmful interference to radio or television reception, which can be determined by turning the equipment off and on, the user is encouraged to try to correct the interference by one or more of the following measures:

- Reorient or relocate the receiving antenna.
- Increase the separation between the equipment and receiver.
- Connect the equipment into an outlet on a circuit different from that to which the receiver is connected.
- Consult the dealer or an experienced radio/TV technician for help.

**Notice:** It is in your own interest to change the factory set Master Code and factory set Emergency Opening Code *before* releasing the locks to users to ensure that you maintain control over the locks. You can change the codes either by manual entry into the lock or by using the LEHMANN Config App (free download for Android devices from your playstore and for iPhones from the Apple App Store). Make sure that you keep a record of the valid Master Code and Emergency Opening Code in a safe place!

## TECHNICAL SPECIFICATIONS

<b>Energy supply</b>	1 x CR123A
<b>Operating temperature</b>	-5 °C to +60 °C
<b>Storage temperature</b>	-25 °C to +70 °C
<b>Type designation</b>	TAMTXPDX



## SAFETY PRECAUTIONS

- Pack the battery for the transport of the lock so that no short circuit can occur (risk of explosion and fire).
- When replacing the battery, make sure that the polarity and position of the battery is correct!
- Dispose of used batteries properly!
- Do not heat batteries, take them apart or short-circuit them!
- Never throw batteries into open fire!
- The battery must not be charged!
- Keep the product away from children, as small parts may be swallowed!
- Any persons swallowing batteries must seek immediate medical advice!
- Damaged and/or leaking batteries may cause acid burns and/or poisoning

## CARE AND MAINTENANCE

- Do not spill any liquid over or into the individual components of the lock, and never immerse the components in any liquid.
- Clean the lock and the components with a clean, soft, damp cloth only.
- Do not use any cleaning agents containing abrasives or solvents, as these may damage the housing.
- Treating any of the electronic and mechanical components improperly or in any way other than described in these operating instructions may lead to malfunctions and the loss of warranty.
- Change the battery in good time. At the latest, when the lock issues corresponding battery warnings.

## FUNCTIONAL DESCRIPTION

With the GIRO TA locking system you can conveniently lock and unlock your furniture. To do this, the lock is turned manually by the user. A PIN code is used as the “key”. Two operating modes are available:

<b>Operating mode</b>	<b>Description</b>
Free Code	The user selects his own individual code (3 to 10 digits) for opening and closing the lock. In this mode, the code memory is deleted again as soon as the user opens his locker. This means that the next user can select his new individual code.
Fix Code	The user can only open and close the lock with a fixed code (3 to 10 digits).

## SYSTEM COMPONENTS AND PACKAGE CONTENTS

Please note that these operating instructions apply to different product versions. The package content therefore depends on the respective product variant. The product variants and mounting recommendations shown here are intended for wooden furniture with a thickness of 16-19 mm. In the case of deviating thicknesses and materials, the screws for mounting the lock and the fixing element must be adapted.

### Mounting on wood

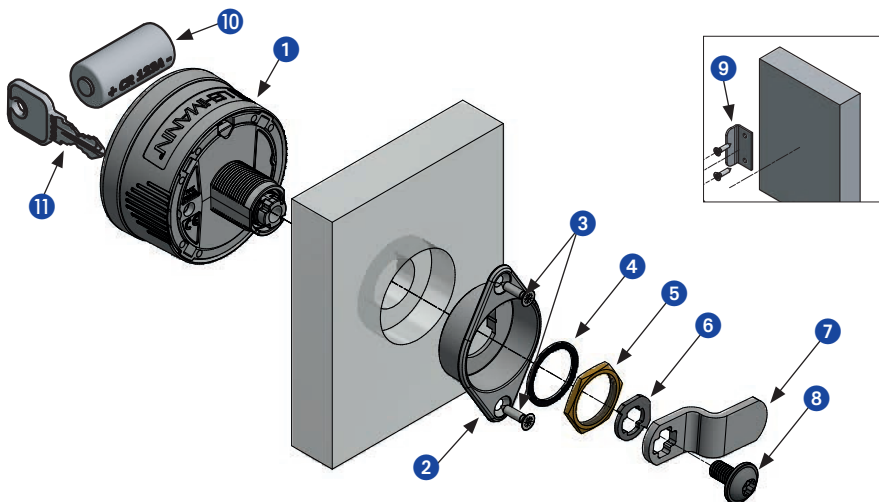

#### Components:

- |                                     |  |
|-------------------------------------|--|
| 1. Lock GIRO TA                     | 7. Bolt (e.g. type 040)                  |
| 2. Fixing element 1619              | 8. Screw TX20n                           |
| 3. Screws 3 x 15 for fixing element | 9. Striker plate 3011 with screws 3 x 15 |
| 4. Sealing ring                     | 10. Battery (CR123A))                    |
| 5. Nut (AF22)                       | 11. Service key (optional)               |
| 6. Limiting plate L/R setting       |  |

Mounting on metal surfaces

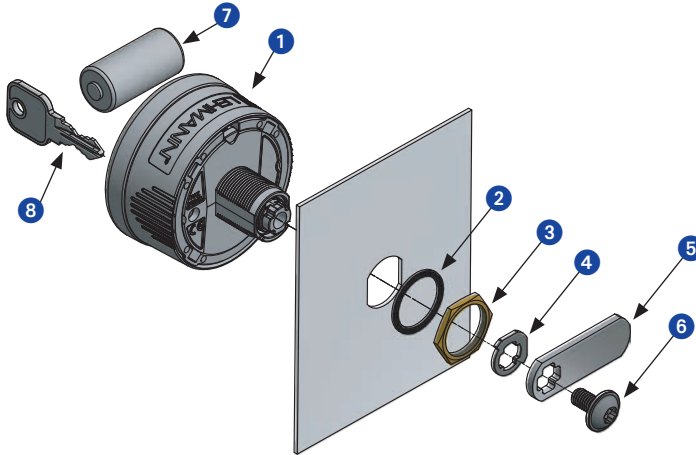

**Components:**

- |                               |                           |
|-------------------------------|---------------------------|
| 1. Lock GIRO TA               | 5. Bolt (e.g. type 031)   |
| 2. Sealing ring               | 6. Screw TX20n            |
| 3. Nut (AF22)                 | 7. Battery (CR123A)       |
| 4. Limiting plate L/R setting | 8. Service key (optional) |

**DIMENSIONS**

Lock Giro TA

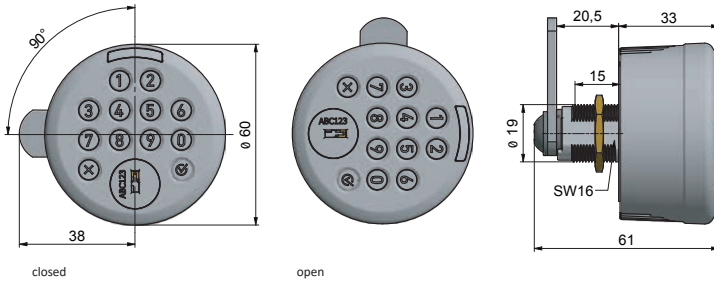

Bolt 031

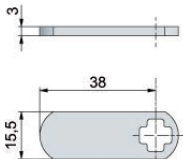

Bolt 039

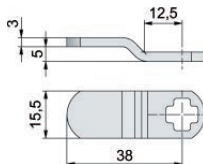

Bolt 040

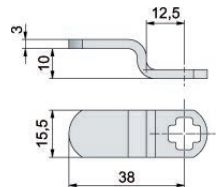

All dimensions in mm.

Striker plate 3011

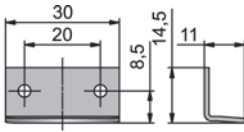

Status indicator (optional)

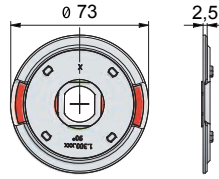

Fixing element 1619

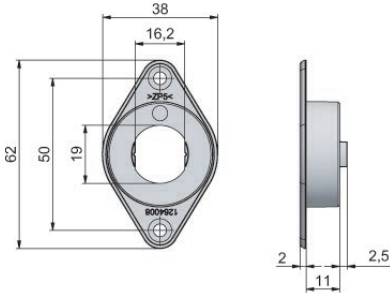

## CHANGE DIRECTION OF ROTATING

The lock can be used for right hand doors and left hand doors.

For right hand doors:

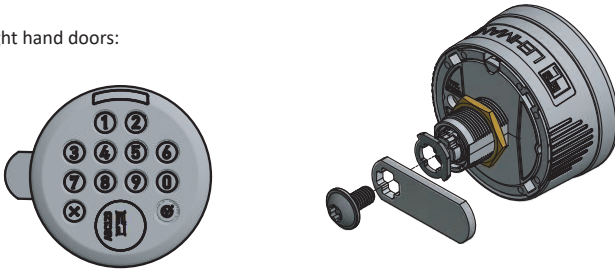

For left hand doors:

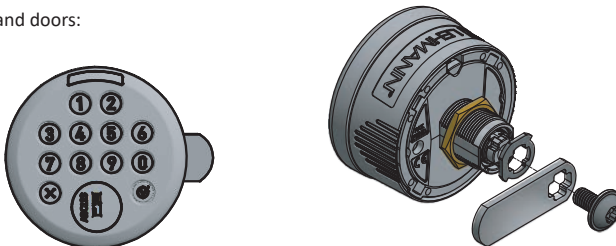

## MOUNTING ON WOOD

**ATTENTION:** Install the lock only when it is unlocked. Carry out all programming processes and functional checks with the cabinet door open.

When mounting on wood, the fixing element 1619 is required. Dimensions refer to bolt type 039.

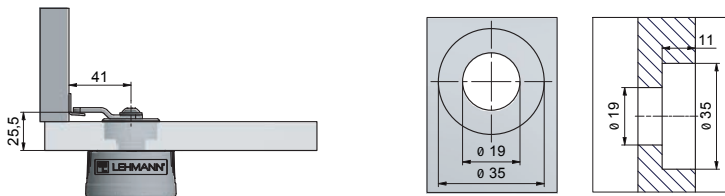

## MOUNTING ON METAL SURFACES

Dimensions refer to bolt type 031.

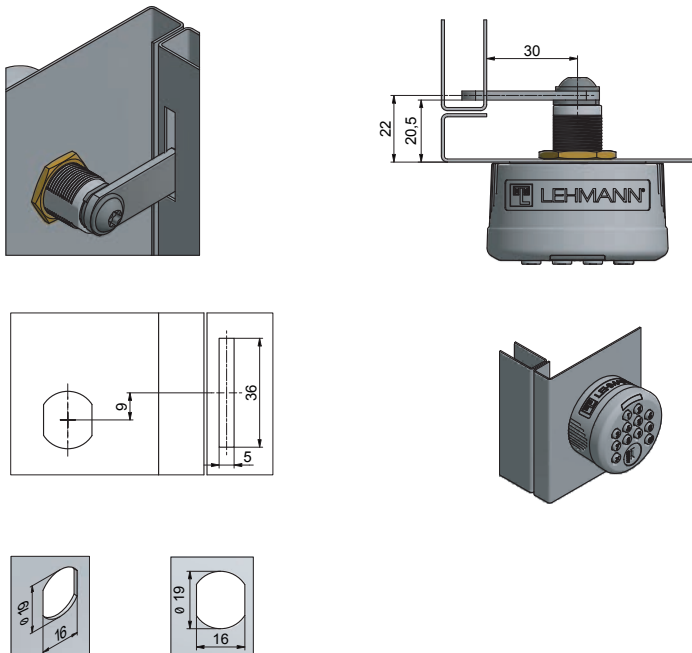

## ASSEMBLY INSTRUCTIONS FOR THE STATUS INDICATOR

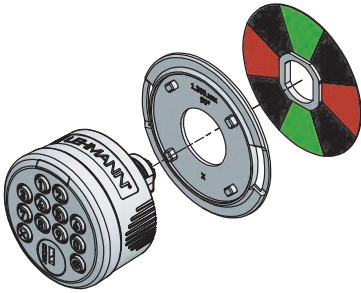

unlocked



locked

## MOUNTING GIRO WITH STATUS INDICATOR ON WOOD

When mounting the lock with the status indicator on wood, the fixing element 1619 is required. Dimensions refer to bolt type 040.

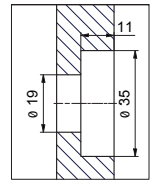
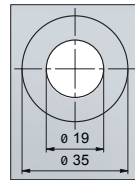
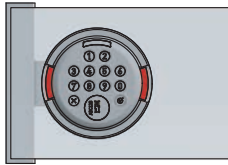
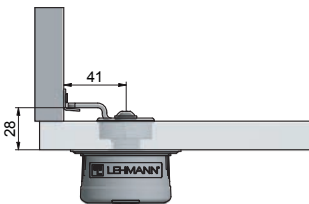

## MOUNTING GIRO WITH STATUS INDICATOR ON METAL SURFACES

Dimensions refer to bolt type 039.

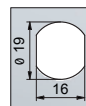
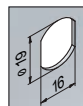
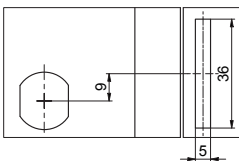
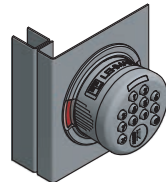
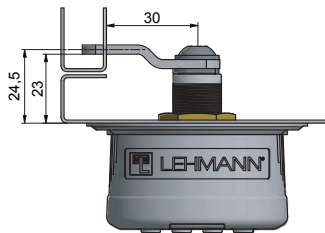
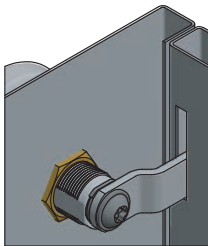



## EMERGENCY OPENING WITH SERVICE KEY

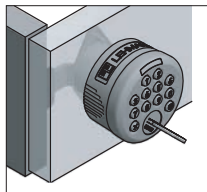

1. Turn the key 45° to the left

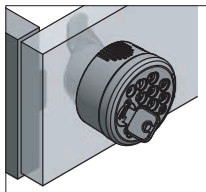

2. Turn the turn knob by 45°

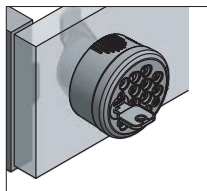

3. Turn the key 45° to the right

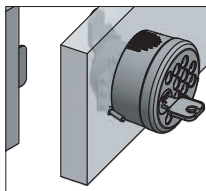

4. Lock is open

## GETTING STARTED AND CHANGING BATTERIES

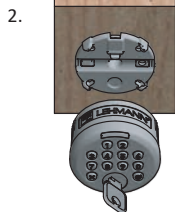
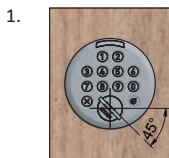

### Inserting the battery

Battery is inserted correctly in the battery compartment.



**IMPORTANT:** Use only a CR123A primary-battery.

## STRUCTURE OF THE KEYPAD

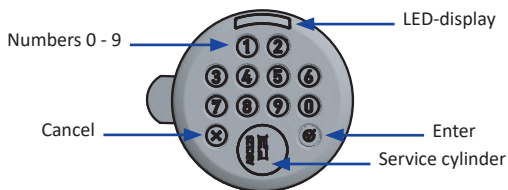



You can cancel any process at any time using the Cancel button (X). When the cancel button is pressed, there is one short red flashing and an acoustic signal. Any input already made is deleted.



During operation, make sure that each key input is acknowledged by an optical signal at the LED display and by an acoustic signal! If an optical light signal does not appear, the key input was not accepted.

The optical and acoustic signals are as follows differentiated:

### Optical signals

	Short flashing
	Long flashing
	Continuous light

### Acoustic signals

	Short
	Long

### Note:

If no further key input is made during the entry of a code or during a programming operation, the already made entries will be discarded after 30 seconds. The old code remains valid.

After the third entry of an invalid code, the option to enter a code is blocked for 30 seconds. The display flashes red nine times. When a key is pressed during these 30 seconds, the LED display flashes red once.

## FACTORY SETTINGS

The following settings apply for the locking system as delivered from the factory:

- Free Code mode
- The lock is unlocked
- Master code: 9-0-8-0-7-0-5-5-5-5
- Emergency opening code: 1-0-1-0-5
- Acoustic signals are activated
- Automatic locking is deactivated

**ATTENTION:** It is highly recommended to change the factory set master code and factory set emergency opening code!

## LOCKING & UNLOCKING IN FREE CODE MODE

The lock must be in open position. You can enter any 3 to 10 digit code for locking. When entering, make sure that each key input is acknowledged by a light signal at the LED display and by an acoustic signal.

After opening by entering the correct code, the previous code will be deleted. The lock can now be locked again with any 3 to 10 digit code.

If an invalid code is entered, the LED display flashes red three times together with acoustic signals.

Locking (example: 1-4-5-6)			
Keys			
Optical signals			The lock is locked.
Acoustic signals			

Unlocking (example: 1-4-5-6)			
Keys			
Optical signals			The lock is unlocked.
Acoustic signals			

## SWITCHING TO FIXED CODE MODE

The lock must be in open position. There must be no battery warning. The fixed code must be 3 to 10 digits. If you have already changed the default master code, enter your valid master code here. In order to confirm the master code, press the keys + **simultaneously**.

Enter of master code (example: factory settings)			
Keys			The lock is in configuration mode (continuous green light).
Optical signals			
Acoustic signals			

Keys			The lock waits for entering a new fixed code (continuous green light).
Optical signals			
Acoustic signals			

The LED display first flashes red twice after pressing the enter button and then turns to a continuous green light until a new fixed code has been entered.

Now enter your new personal fixed code **immediately**. When entering, make sure that each key input is acknowledged by a light signal at the LED display and by an acoustic signal.

continue on page 12

Enter of new fixed code (example: 1-4-5-6)	
Keys	① ④ ⑤ ⑥ ✓
Optical signals	■ ■ ■ ■ ■
Acoustic signals	🔊 🔊 🔊 🔊 🔊
	When the LED display turns off, the new fixed code is valid.

If you cancel the enter process of a new fixed code with the cancel button or if you enter an incorrect code (invalid code length), the code 1-2-3 will automatically be valid. In this case the LED display flashes red ten times together with acoustic signals.

Check that the code has been accepted correctly with an open cabinet door.

Switching to Fixed Code mode deactivates the function „Automatic opening in Free Code mode“ or „Automatic locking in Fixed Code mode“ which may have been activated before.

## LOCKING AND UNLOCKING IN FIXED CODE MODE

Locking (example: 1-4-5-6)	
Keys	① ④ ⑤ ⑥ ✓
Optical signals	■ ■ ■ ■ ■ ■
Acoustic signals	🔊 🔊 🔊 🔊 🔊 🔊
	The lock is locked.

Unlocking (example: 1-4-5-6)	
Keys	① ④ ⑤ ⑥ ✓
Optical signals	■ ■ ■ ■ ■
Acoustic signals	🔊 🔊 🔊 🔊 🔊
	The lock is unlocked.

If an invalid code is entered, the LED display flashes red three times together with acoustic signals.

## USER CHANGES THE FIXED CODE

The lock must be in open position. There must be no battery warning. The fixed code must be 3 to 10 digits.

If you have already changed the default fixed code, enter your valid code here.

The previous code will be overwritten by entering the new code.

Enter of valid fixed code (example: 1-4-5-6)	
Keys	① ④ ⑤ ⑥ x + ✓ simultaneously
Optical signals	■ ■ ■ ■ ■ ■
Acoustic signals	🔊 🔊 🔊 🔊 🔊
	The lock waits for entering a new fixed code (continuous green light).

After the buttons  $\textcircled{\times}$  +  $\textcircled{\checkmark}$  are pressed simultaneously, the LED will turn to a continuous green light until a new fixed code is entered.

Now enter your new personal fixed code immediately. When entering, make sure that each key input is acknowledged by a light signal at the LED display and by an acoustic signal.

Enter of new fixed code (example: 1-2-3-4-5)	
Keys	$\textcircled{1}$ $\textcircled{2}$ $\textcircled{3}$ $\textcircled{4}$ $\textcircled{5}$ $\textcircled{\checkmark}$
Optical signals	
Acoustic signals	
	When the LED display turns off, the new fixed code is valid.

If the new code is not entered correctly, the previous code remains valid. In this case, the LED display flashes red ten times together with acoustic signals.

Check with the open cabinet, that the new fixed code has been accepted correctly (see page 12, „Locking and unlocking in Fixed Code mode“).

## SWITCHING TO FREE CODE MODE

The lock must be in open position. There must be no battery warning. If you have already changed the default master code, enter your valid master code here. In order to confirm the master code, press the keys  $\textcircled{\times}$  +  $\textcircled{\checkmark}$  simultaneously.

Enter of master code (example: factory settings)	
Keys	$\textcircled{9}$ $\textcircled{0}$ $\textcircled{8}$ $\textcircled{0}$ $\textcircled{7}$ $\textcircled{0}$ $\textcircled{5}$ $\textcircled{5}$ $\textcircled{5}$ $\textcircled{5}$ $\textcircled{\times}$ + $\textcircled{\checkmark}$ simultaneously
Optical signals	
Acoustic signals	
	The lock is in configuration mode (continuous green light).
Keys	$\textcircled{1}$ $\textcircled{\checkmark}$
Optical signals	
Acoustic signals	
	When the LED display turns off, Free Code mode is activated.

After you have successfully switched to Free Code mode, you can operate the lock with any random code (3 to 10 digits). Please refer to page 11, „Locking and unlocking in Free Code mode“.



Switching to Free Code mode deactivates the function „Automatic locking in Fixed Code mode“ or „Automatic opening in Free Code mode“ which may have been activated before.













































## CHANGING THE MASTER CODE

It is highly recommended that you change the default master code and to choose the longest possible and secure master code.

The lock must be in open position. There must be no battery warning.



















The master code must be 3 to 10 digits.



















If you have already changed the default master code, enter your valid master code here. In order to confirm the master code, press the keys  +  simultaneously.

Enter of master code (example: factory settings)		
Keys	           + 	The lock is in configuration mode (continuous green light).
Optical signals	            simultaneously	
Acoustic signals	           	
Keys	 	The lock waits for the first entry of the new master code (continuous red light).
Optical signals	   	
Acoustic signals	 	

After the enter button is pressed the LED display will turn to a continuous red light until a new master code has been entered for the first time.

Now carefully enter the new master code 2x in succession (as described in the following). When entering the new master code, make sure that each key input is acknowledged by a light signal at the LED display and by an acoustic signal.

Enter of new master code (example: 6-0-1-9-7)		
Keys	     	The lock waits for the second entry of the new master code (continuous green light).
Optical signals	     	
Acoustic signals	     	

Repeat enter of new master code (example: 6-0-1-9-7)		
Keys	     	When the LED display turns off, the new master code is valid.
Optical signals	     	
Acoustic signals	     	

If the new master code has been entered correctly twice, there is a long green flashing in the LED display together with an acoustic signal. The new master code is valid. In all other cases, the LED display flashes red ten times together with acoustic signals. The new master code was not accepted. The previous master code is still valid.

Perform immediately a functional test with the new master code!

## CHANGING THE EMERGENCY OPENING CODE

It is highly recommended that you change the default emergency opening code and to choose the longest possible and secure emergency opening code. The lock must be in open position. There must be no battery warning. The emergency opening code must be 3 to 10 digits.

If you have already changed the default master code, enter your valid master code here. In order to confirm the master code, press the keys **X** + **✓** simultaneously.

Enter of master code (example: factory settings)			
Keys			The lock is in configuration mode (continuous green light).
Optical signals			
Acoustic signals			
Keys			The locks waits for the first entry of the the new emergency opening code (continuous red light).
Optical signals			
Acoustic signals			

After the enter button is pressed the LED display will turn to a continuous red light until a new emergency opening code has been entered for the first time.

Now carefully enter the new emergency opening code **2x** in succession (as described in the following).

When entering the new emergency opening code, make sure that each key input is acknowledged by a light signal at the LED display and by an acoustic signal.

Enter of new emergency opening code (example: 1-2-3-0-0)			
Keys			The lock waits for the second entry of the new emergency opening code (continuous green light).
Optical signals			
Acoustic signals			
Repeat enter of new emergency code (example: 1-2-3-0-0)			
Keys			When the LED display turns off, the new emergency opening code is valid.
Optical signals			
Acoustic signals			

If the new emergency opening code has been entered correctly twice, there is a long green flashing in the LED display together with an acoustic signal. The new emergency opening code is valid. In all other cases, the LED display flashes red ten times together with acoustic signals. The new emergency opening code was not accepted. The previous emergency opening code is still valid.

Perform immediately a functional test with the new emergency opening code!

## EMERGENCY OPENING

If you have already changed the default emergency opening code, enter your valid emergency opening code here.

Enter emergency opening code (example: factory settings)	
Keys	
Optical signals	
Acoustic signals	
	The lock is unlocked.

After an emergency opening in the Fixed Code mode, the lock can be used again normally with the previously programmed fixed code. If you want to change the fixed code, follow the instructions in section „User changes the Fixed code“ or in section “Switching to Fixed Code mode”.

After an emergency opening in the Free Code mode, the lock can be used normally again (see page 11, „Locking & unlocking in Free Code mode“).

If an invalid emergency opening code is entered, the LED display flashes red three times together with acoustic signals.

## RESET TO FACTORY SETTINGS

If the reset to factory settings is carried out, all stored fixed code, master code, emergency opening code and all other settings will be deleted.

The lock must be in open position. There must be no battery warning. If necessary, perform an emergency opening to open the lock.

If you have already changed the default master code, enter your valid master code here. In order to confirm the master code, press the keys + simultaneously.

Enter of master code (example: factory settings)	
Keys	
Optical signals	
Acoustic signals	
Keys	
Optical signals	
Acoustic signals	
	The lock is in configuration mode (continuous green light).
	When the LED display turns off, the reset to factory settings is completed.



## AUTOMATIC LOCKING IN FIXED CODE MODE

The lock must be in open position. There must be no battery warning. This feature can only be activated in Fixed Code mode. If you have already changed the default master code, enter your valid master code here. In order to confirm the master code, press the keys **(X)** + **(✓)** simultaneously.

Enter of master code (example: factory settings)		
Keys Optical signals Acoustic signals	<div style="display: flex; justify-content: space-around; align-items: center;"> <span>9</span><span>0</span><span>8</span><span>0</span><span>7</span><span>0</span><span>5</span><span>5</span><span>5</span><span>5</span> <span style="margin-left: 10px;">(X) + (✓) simultaneously</span> </div> <div style="display: flex; justify-content: space-around; align-items: center; margin-top: 5px;"> <span style="width: 15px; height: 10px; background-color: yellow;"></span> <span style="width: 15px; height: 10px; background-color: yellow;"></span> <span style="width: 15px; height: 10px; background-color: yellow;"></span> <span style="width: 15px; height: 10px; background-color: yellow;"></span> <span style="width: 15px; height: 10px; background-color: yellow;"></span> <span style="width: 15px; height: 10px; background-color: yellow;"></span> <span style="width: 15px; height: 10px; background-color: yellow;"></span> <span style="width: 15px; height: 10px; background-color: yellow;"></span> <span style="width: 15px; height: 10px; background-color: yellow;"></span> <span style="width: 15px; height: 10px; background-color: yellow;"></span> <span style="width: 15px; height: 10px; background-color: green;"></span> </div> <div style="display: flex; justify-content: space-around; align-items: center; margin-top: 5px;"> <span>🔊</span><span>🔊</span><span>🔊</span><span>🔊</span><span>🔊</span><span>🔊</span><span>🔊</span><span>🔊</span><span>🔊</span><span>🔊</span><span>🔊</span><span>🔊</span> </div>	The lock is in configuration mode (continuous green light).
Keys Optical signals Acoustic signals	<div style="display: flex; justify-content: space-around; align-items: center;"> <span>6</span><span>(✓)</span> </div> <div style="display: flex; justify-content: space-around; align-items: center; margin-top: 5px;"> <span style="width: 15px; height: 10px; background-color: yellow;"></span> <span style="width: 15px; height: 10px; background-color: red;"></span> </div> <div style="display: flex; justify-content: space-around; align-items: center; margin-top: 5px;"> <span>🔊</span><span>🔊</span> </div>	The lock waits for the selection of the time span (continuous red light).

Select the time span after which the lock is locked automatically.

Selection of time spans	Automatic locking	Selection of time spans	Automatic locking
Keys Optical signals Acoustic signals		Keys Optical signals Acoustic signals	
Keys Optical signals Acoustic signals	Switches off	Keys Optical signals Acoustic signals	after 15 minutes
Keys Optical signals Acoustic signals	after 10 seconds	Keys Optical signals Acoustic signals	after 1 hour
Keys Optical signals Acoustic signals	after 30 seconds	Keys Optical signals Acoustic signals	after 6 hours
Keys Optical signals Acoustic signals	after 1 minute	Keys Optical signals Acoustic signals	after 12 hours
Keys Optical signals Acoustic signals	after 5 minutes	Keys Optical signals Acoustic signals	after 24 hours

Note that there may be slight variations in the time span. A second-exact measurement is not possible. When switching to the Free Code mode, this function is automatically deactivated.

## AUTOMATIC OPENING IN FREE CODE MODE

The lock must be in open position. There must be no battery warning. This feature can only be activated in Free Code mode. If you have already changed the default master code, enter your valid master code here. In order to confirm the master code, press the keys (X) + (✓) simultaneously.

Enter of master code (example: factory settings)		
Keys	+ simultaneously	The lock is in configuration mode (continuous green light).
Optical signals		
Acoustic signals		
Keys		The lock waits for the selection of the time span (continuous red light).
Optical signals		
Acoustic signals		

Select the time span after which the lock is opened automatically.

Selection of time spans	Automatic opening	Selection of time spans	Automatic opening
Keys Optical signals Acoustic signals	Switches off	Keys Optical signals Acoustic signals	after 6 hours
Keys Optical signals Acoustic signals	after 5 minutes	Keys Optical signals Acoustic signals	after 12 hours
Keys Optical signals Acoustic signals	after 15 minutes	Keys Optical signals Acoustic signals	after 24 hours
Keys Optical signals Acoustic signals	after 30 minutes	Keys Optical signals Acoustic signals	after 48 hours
Keys Optical signals Acoustic signals	after 1 hour	Keys Optical signals Acoustic signals	after 7 days

Note that there may be slight variations in the time span. A second-exact measurement is not possible. When switching to the Fixed Code mode, this function is automatically deactivated.

## ACTIVATION AND DEACTIVATION OF ACOUSTIC SIGNALS

The lock must be in open position. There must be no battery warning. If you have already changed the default master code, enter your valid master code here. In order to confirm the master code, press the keys **X** + **✓** simultaneously.





Enter of master code (example: factory settings)		
Keys		The lock is in configuration mode (continuous green light).
Optical signals		
Acoustic signals		
Keys		Acoustic signals are <b>activated</b> or <b>deactivated</b> .
Optical signals		
Acoustic signals		

## CONFIGURATION OF THE LOCK WITH THE NFC-APP

The lock Giro TA can be configured either manually or with the LEHMANN Config app. After putting the app into operation on an Android smartphone or Apple iPhone, configuration changes can be made via the app.

After starting the app, select "PIN Code" in the lower left area of the display. Once selected, the icon will be white and clearly visible. The fingerprint symbol on the right side of the display is nearly hidden.

Three functions are available in the upper display area:

<p><b>Profile</b></p>	<p>This function can be used to create and save configuration profiles on the smartphone. Configuration profiles that have already been created are displayed here. To create a profile, click on "Create new profile". Assign a unique name for the configuration profile. Enter the desired configuration in the appropriate fields. Make sure to enter the valid master code at the end of the input mask. Finally, click on the Save button .</p> <p>To make changes to a configuration profile, select the configuration profile by briefly clicking on the name of the configuration profile in the overview. Enter the desired changes and click the Save button .</p> <p>If changes have been entered but you do not want them to be saved, click the Back button .</p> <p>To return to the profile overview from a configuration profile, click the Back button .</p> <p>To transfer a configuration profile to the lock, select the configuration profile, check the current master code and click Transfer. Hold the NFC antenna of the smartphone in front of the NFC antenna on the lock (see Data transfer to a keypad lock).</p> <p>To delete a configuration profile, press and hold on the name of the configuration profile in the overview of profiles. The delete symbol appears to the right of the profile .</p> <p><b>ATTENTION:</b> If the master code was changed in the configuration profile at "New Master Code" and transferred to the lock, then this new master code must be entered in the configuration profile at "Current Master Code" for future configuration changes.</p>
<p><b>Manuelle configuration</b></p>	<p>This feature allows configuration changes to be made without saving a configuration profile. Configuration changes are entered in the appropriate fields. To transfer the configuration to the lock, check the current master code and click "Transfer". Hold the NFC antenna of the smartphone in front of the NFC antenna on the lock (see Data transfer to a keypad lock).</p>
<p><b>Direct</b></p>	<p>With this function the "Reset" can be selected. The lock is set to the factory delivery mode. Select "Reset" and enter the current master code. To transmit the reset command to the lock, click "Transfer". Hold the NFC antenna of the smartphone in front of the NFC antenna on the lock (see Data transfer to a keypad lock).</p>

### Data transfer to a keypad lock:

To transfer configurations or direct commands to the lock, first check the position of the NFC antenna on your smartphone. Activate the NFC interface on your smartphone.

Click on the „Transfer“ button in the LEHMANN Config App.

Hold the NFC antenna of your smartphone at the marked location on the corresponding lock. The NFC antenna in the lock is located in this area.



Giro TA



During data transfer, the LED lights up yellow. After a successful data transfer, a tick appears in the app. An acoustic signal follows at the lock.

## BATTERY WARNING

The locking system is equipped with a battery management, which uses optical and acoustic signals to indicate that the battery needs to be changed when the battery power drops. The battery warning occurs in two phases:

Warning level	LED-Display	Meaning
Stage 1		The battery is weak and should be changed. Opening and closing of the lock are possible. Configuration changes are not possible.
Stage 2		The battery is exhausted and must be changed immediately! The lock can only be opened. Configuration changes are not possible.

## UPDATE OF FIRMWARE

You have the option of updating the firmware of the locking system. A special adapter is required for the firmware update. Firmware updates for this locking system are only made available on the website [www.lehmann-locks.com](http://www.lehmann-locks.com) if necessary (e.g. technical necessity). Further information on implementation and installation will be provided together with the firmware update.



## DISPOSAL

Dispose of the locking system according to local regulations and guidelines. Remove the battery and dispose of the battery separately according to local regulations. When disposing of partially discharged batteries, make sure that there are no short circuits between the poles of the batteries (risk of explosion and fire).

**NOTE**

---

---

---

---

---

---

---

---

---

---

---

---

---

---

---

---

---

---

---

---

---

---

---

---

---

---

---

---

---

---

**LEHMANN Vertriebsgesellschaft mbH & Co. KG**  
Postfach 26 20 • D-32383 Minden  
Fon +49 571/50 599-0 • Fax +49 571/50 599-822  
info@lehmann-locks.com • www.lehmann-locks.com  
DIN EN ISO 9001:2015 zertifiziert