



GIRO RFID MIFARE

Operating Instructions

Content	Page
General Description	2
Technical Specifications / Safety Precautions / Care and Maintenance / Factory Settings	3
Functional Description / Overview of transponder cards	4
System components and package contents	5
Dimensions	7
Change direction of rotating / Mounting on wood	8
Mounting on metal surfaces / Assembly instructions for the status indicator	9
Mounting GIRO with the status indicator on wood / on metal.....	10
Emergency opening with service key / Getting started and changing batteries / Tips for the following programming steps	11
Using the installation card / Programming the Master card / Prog. the User Cards	12
Closing and Opening	13
Unauthorised Transponder Cards / Facility Manager Function / Emergency Opening	14
Deleting Individual Transponder Cards / Deleting all Transponder Cards	15
Changing the Operating Mode / Deactivating and Activating Acoustic Signals	16
Resetting to Factory Setting	17
Activation and Deactivation of Automatic Locking	18
Activation and Deactivation of Unlimited Shared Use / Battery Warning / Reordering Master Cards / Firmware Update	19
Disposal / Trouble Shouting	20

GENERAL DESCRIPTION

The GIRO RFID MIFARE lock is a battery-operated electronic furniture lock based on RFID technology, which is intended for the inside of buildings. These operating instructions provide you with information on how to operate the locking system without errors. Keep the operating instructions in an easily accessible place. Improper use can destroy the locking system and lead to the loss of any warranty claims.

Please be sure to observe all warnings and read the operating instructions completely before proceeding with installation, commissioning and programming. It may be possible to use our locks and locking systems together with mechanisms made by other manufacturers, but their compatibility must be checked in each individual case. We cannot accept any liability for damage or loss due to incompatibility.

Wording and graphics have been prepared with care. However, no liability will be assumed for any mistakes that may have occurred. Technical specifications as well as the scope of items in the system are subject to change without notice.

CAUTION: The lock can be configured with master and programming cards or with the LEHMANN Management Software LMS. These operating instructions describe how to use the locking system with master and programming cards. The software LMS and the corresponding documents can be found at <https://lms.lehmann-locks.com>.

Regulatory Information for USA and Canada:

FCC ID: W2Y-L5NF13DX

This device complies with Part 15 of the FCC Rules. Operation is subject to the following two conditions:

(1) this device may not cause harmful interference, and (2) this device must accept any interference received, including interference that may cause undesired operation.

Changes or modifications not expressly approved by the party responsible for compliance could void the user's authority to operate the equipment.

IC: 8141A-L5NF13DX

HVIN: L5NF13DX

This device contains licence-exempt transmitter(s)/receiver(s) that comply with Innovation, Science and Economic Development Canada's licence-exempt RSS(s). Operation is subject to the following two conditions:

1. This device may not cause interference.
2. This device must accept any interference, including interference that may cause undesired operation of the device.

L'émetteur/récepteur exempt de licence contenu dans le présent appareil est conforme aux CNR d'Innovation, Sciences et Développement économique Canada applicables aux appareils radio exempts de licence.

L'exploitation est autorisée aux deux conditions suivantes :

1. L'appareil ne doit pas produire de brouillage;
2. L'appareil doit accepter tout brouillage radioélectrique subi, même si le brouillage est susceptible d'en compromettre le fonctionnement.

TECHNICAL SPECIFICATIONS

Frequency	13,56 MHz National legislation about permissible radio frequencies must be observed.
RFID technologie	MIFARE® Classic, MIFARE® DESFire® EV1, EV2
Supported transponders	Compatible with the following RFID transponders: • MIFARE® Classic / • MIFARE® DESFire® / • ISO 14443A Existing transponders must be checked for compatibility. MIFARE® Classic transponders are only supported in „Assigned use“ mode. MIFARE® Classic transponders cannot be used with the LMS. Support of NFC-enabled Android smartphones incl. LEHMANN Transponder App when configured by master card or LEHMANN Management Software LMS 2.x. Firmware vers. 2.x is required in the lock.
Energy supply	Batterietyp: 1 x CR123A
Operating temperature	-5 °C to +60 °C
Storage temperature	-25 °C to +70 °C
Type designation	L5NF13DX



SAFETY PRECAUTIONS

- Pack the battery for the transport of the lock so that no short circuit can occur (risk of explosion and fire).
- When replacing the battery, make sure that the polarity and position of the battery is correct!
- Dispose of used batteries properly!
- Do not heat batteries, take them apart or short-circuit them!
- Never throw batteries into open fire!
- The battery must not be charged!
- Keep the product away from children, as small parts may be swallowed!
- Any persons swallowing batteries must seek immediate medical advice!
- Damaged and/or leaking batteries may cause acid burns and/or poisoning!

CARE AND MAINTENANCE

- Do not spill any liquid over or into the individual components of the lock, and never immerse the components in any liquid.
- Clean the lock and the components with a clean, soft, damp cloth only.
- Do not use any cleaning agents containing abrasives or solvents, as these may damage the housing.
- Treating any of the electronic and mechanical components improperly or in any way other than described in these operating instructions may lead to malfunctions and the loss of warranty.
- Change the battery in good time. At the latest, when the lock issues corresponding battery warnings.

FACTORY SETTINGS

The lock can be closed and opened at this point of time with one or more installation cards. After a Master card has been programmed, the lock is in the operating mode “assigned use” and the installation card cannot be used any more.

FUNCTIONAL DESCRIPTION

With the GIRO RFID MIFARE lock, you can conveniently lock and unlock your furniture. Non-contact RFID technology based on 13.56 MHz is used as the “key”. Two operating modes are available:

Operating mode	Description
Assigned use	There is a fixed assignment between the transponder cards and the locks. The user cards are programmed or deactivated at the lock by means of a master card. The system thus allows the granting of selective access authority for an item of furniture (e.g. cabinet), so that only authorised persons with a transponder card have access. A transponder card can be programmed simultaneously on multiple locks with “Assigned use” operating mode. Up to 250 different transponder cards can be programmed per lock.
Shared use	With the user card, a user can use a free lock / storage of his choice. It is not possible to program the user card by using the master card. If a lock is closed with the user card, the user card and the lock are coupled to each other. The card cannot be used at any other lock in “shared use” mode, and the lock will not accept any other user card. This coupling is only deactivated when the user opens the lock again with his user card. The card can now be used for another lock. In conjunction with the programming card P6: Unlimited Shared Use, it is possible for an RFID transponder to close several locks at the same time (note: even up to all locks!), instead of just one lock per transponder in this operating mode.

Please note that the distance between two or more locks with an inserted battery must be at least 10 cm (lateral distance) and 15 cm (frontal distance) during storage, transport and operation.



OVERVIEW OF TRANSPONDER CARDS

Card type	Description
Installation card (only for assembly and testing purposes)	The installation card can be used specially for assembly and testing purposes in order to perform basic functions on the lock (opening and closing). Furthermore, the lock can be closed using the installation card for transporting the furniture to its destination. This card is for universal use. Any number of installation cards can be used at any lock. Prior programming of a master card is not necessary. After a master card has been programmed for the first time, the lock is disabled for the installation card. The use of an installation card is optional.
Master card	For complete commissioning, a master card must be programmed for both operating modes. The master card is required for starting and terminating programming operations. This also includes the programming of user cards in “Assigned use” mode. The master card also enables the so-called Facility Manager function and the emergency opening of the lock. A maximum of one master card can be programmed per lock. You can use one master card for several locks.
User card	User cards are used to open and close the lock. In “Assigned use” mode, up to 250 user cards can be programmed on one lock. In “Shared use” mode, one user card can be used temporarily on one lock. It is possible to program one user card on several locks in “Assigned use” mode, and at the same time on one lock in “Shared use” mode.

Programming card set	For certain programming functions, programming cards are required in conjunction with the master card. The programming card set consists of 3 universal programming cards: <ul style="list-style-type: none"> • P1: Mode (change of mode) • P2: Sound (activating or deactivating acoustic signals) • P3: Reset (reset to factory settings)
Programming card "P4: Auto Locking"	The universal programming card "P4: Auto Locking" can only be used in the operating mode "assigned use". The function can be activated together with the master card. After opening the lock with a programmed transponder in the operating mode "assigned use", the lock closes automatically after 5 seconds once this function has been activated.
Programming card „P6: Unlimited Shared Use“	The programming card „P6: Unlimited Shared Use“ can be used in the „shared use“ mode. After activation, an RFID transponder can lock several locks at the same time (caution: even up to all locks!), instead of just one lock per transponder in this operating mode.
Update card	In addition to the master card, you will receive an update card. In conjunction with the master card, the update card allows firmware updates to be loaded into this lock.
Service key	In addition to the master card, you will receive a card with an individual service key. Please keep the card with the service key carefully and securely. The printed service key allows you to reorder master cards. It is not possible to reorder a master card without a service key! This card has no electronic function!

As user cards, you can either use LEHMANN user cards or cards of a third-party provider complying with ISO 14443A. Please note the following possible restrictions when using user cards of third-party providers:

- The comprehensive security concept, which was specially designed for this locking system in conjunction with the user cards of LEHMANN Vertriebsgesellschaft mbH & Co. KG, may be affected by the use of user cards of a third-party provider.
- The "Shared use" operating mode is only possible with user cards from third-party providers if they have the appropriate write permission for the user card.
- Transponder cards with a so-called "Random-UID" are not supported.

CAUTION: Transponders from third-party providers must be checked for compatibility in advance.

For the highest possible level of safety, transponder cards based on MIFARE® DESFire are recommended.

MIFARE® Classic transponders are of limited use (only in „assigned use“ mode; not with LMS).

Please note that installation cards, master cards, user cards and programming cards must be ordered separately.

Please keep the master card as well as the card with the individual service key carefully and securely!

SYSTEM COMPONENTS AND PACKAGE CONTENTS

Please note that these operating instructions apply to different product versions. The package content therefore depends on the respective product variant. The product variants and mounting recommendations shown here are intended for wooden furniture with a thickness of 16-19 mm. In the case of deviating thicknesses and materials, the screws for mounting the lock and the fixing element must be adapted.

Mounting on wood

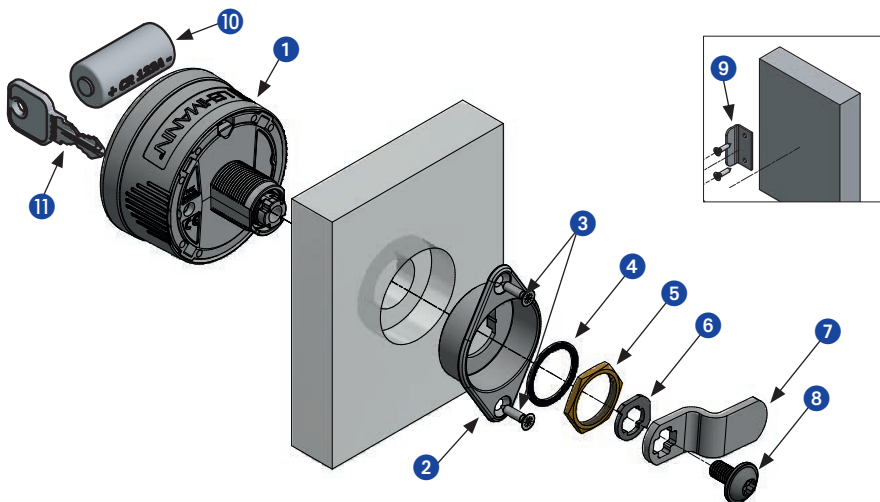

Components:

- | | |
|-------------------------------------|--|
| 1. Lock GIRO RFID MIFARE | 7. Bolt (e.g. type 040) |
| 2. Fixing element 1619 | 8. Screw TX20n |
| 3. Screws 3 x 15 for fixing element | 9. Striker plate 3011 with screws 3 x 15 |
| 4. Sealing ring | 10. Battery (CR123A) |
| 5. Nut (AF22) | 11. Service key (optional) |
| 6. Limiting plate L/R setting | |

Mounting on metal surfaces

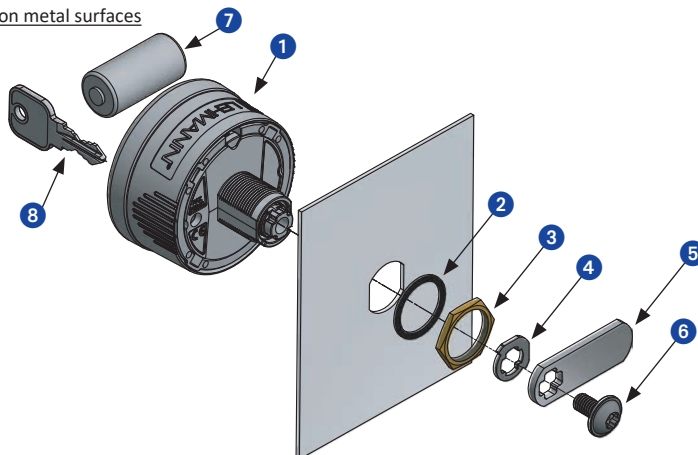

Components:

- | | |
|-------------------------------|---------------------------|
| 1. Lock GIRO RFID MIFARE | 5. Bolt (e.g. type 031) |
| 2. Sealing ring | 6. Screw TX20n |
| 3. Nut (AF22) | 7. Battery (CR123A) |
| 4. Limiting plate L/R setting | 8. Service key (optional) |

DIMENSIONS

Lock Giro RFID MIFARE

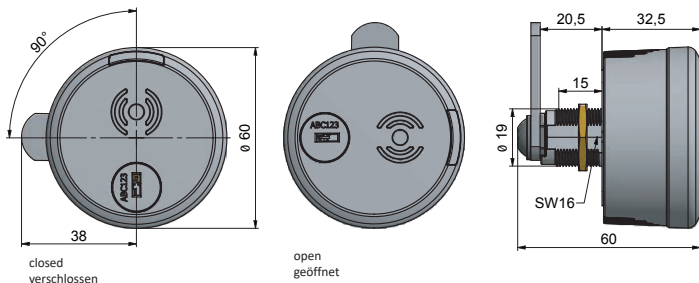

Bolt 031

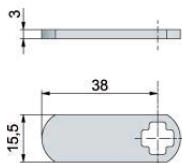

Bolt 039

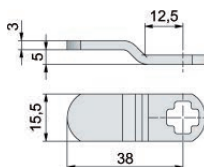

Bolt 040

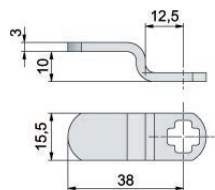

Striker plate 3011

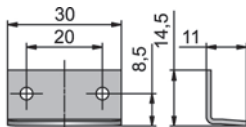

Status indicator (optional)

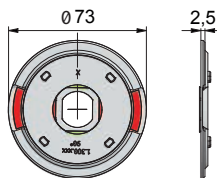

Fixing element 1619

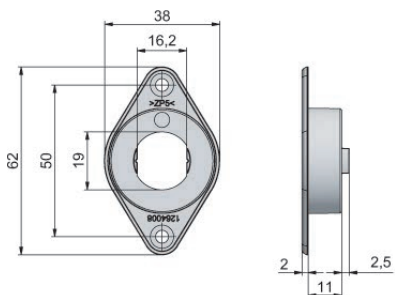

CHANGE DIRECTION OF ROTATING

The lock can be used for right hand doors and left hand doors..

For right hand doors:

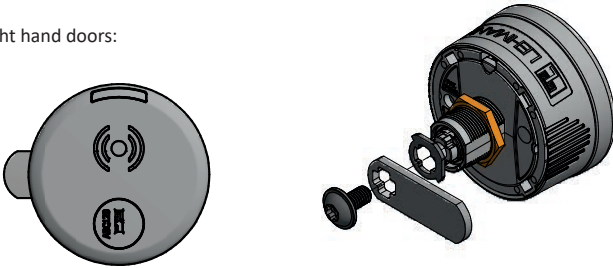

For left hand doors:

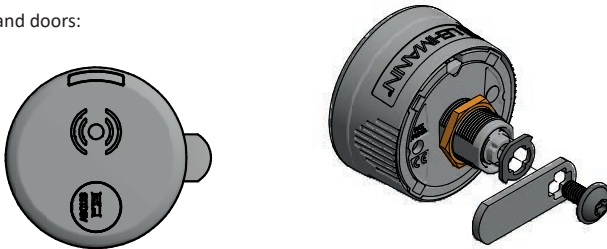

MOUNTING ON WOOD

ATTENTION: Install the lock only when it is unlocked. Carry out all programming processes and functional checks with the cabinet door open.

When mounting on wood, the fixing element 1619 is required. Dimensions refer to bolt type 039.

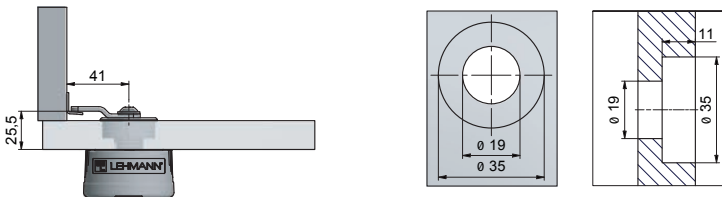

MOUNTING ON METAL SURFACES

Dimensions refer to bolt type 031.

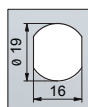
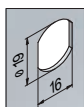
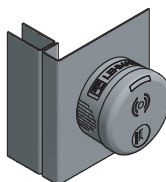
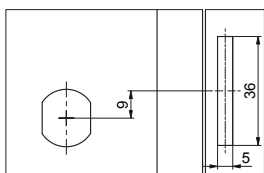
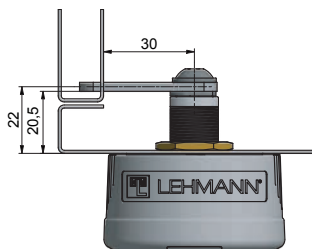
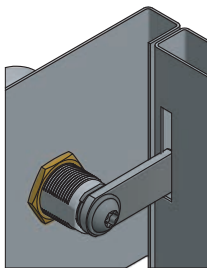

ASSEMBLY INSTRUCTIONS FOR THE STATUS INDICATOR

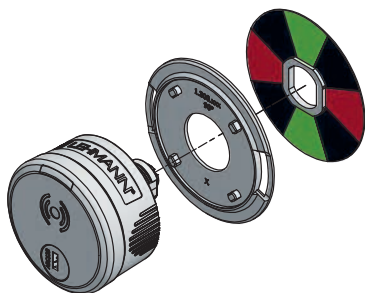

unlocked



locked

MOUNTING GIRO WITH STATUS INDICATOR ON WOOD

When mounting the lock with the status indicator on wood, the fixing element 1619 is required.
Dimensions refer to bolt type 040.

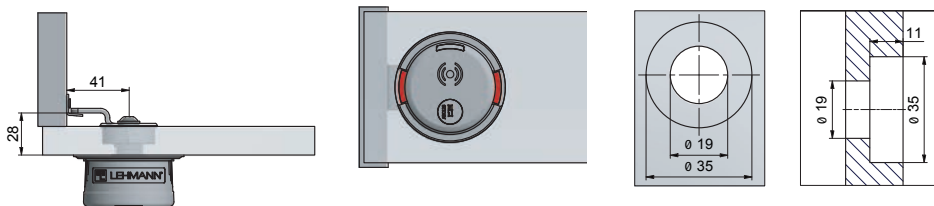

MOUNTING GIRO WITH STATUS INDICATOR ON METAL SURFACES

Dimensions refer to bolt type 039.

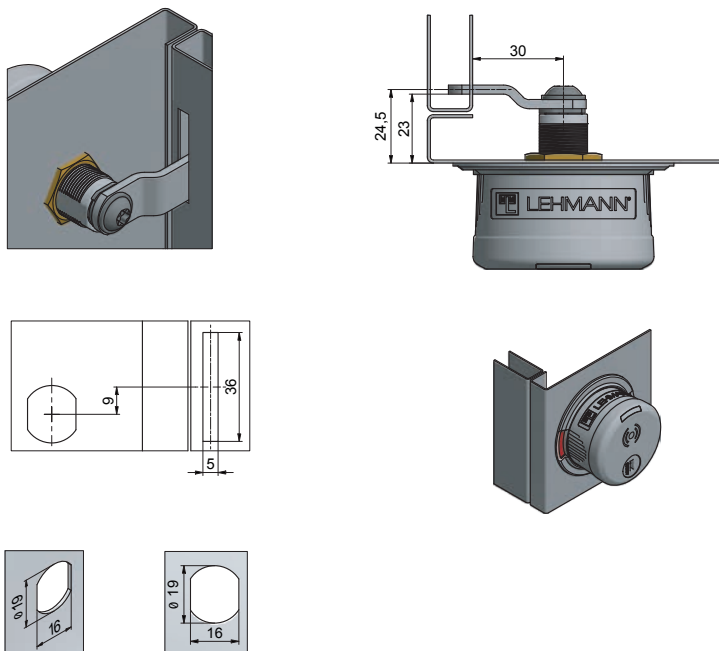

EMERGENCY OPENING WITH SERVICE KEY

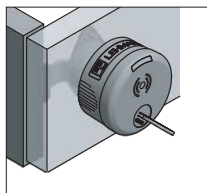

1. Turn the key 45° to the left

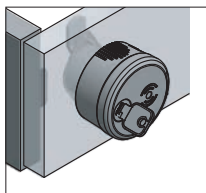

2. Turn the turn knob by 45°

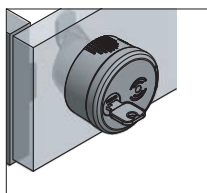

3. Turn the key 45° to the right

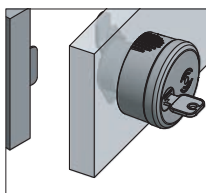

4. Lock is open

GETTING STARTED AND CHANGING BATTERIES

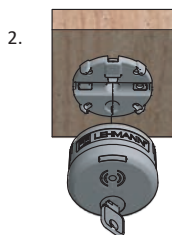
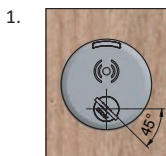

Inserting the battery

Battery is inserted correctly in the battery compartment





IMPORTANT: Use only a CR123A primary-battery.



TIPS FOR THE FOLLOWING PROGRAMMING STEPS

The last 5 seconds before the shutdown of the programming process are announced by the flashing of a yellow lamp and acoustic signals. The visual and acoustic signals are differentiated as follows.

Optical signals

-  Short flashing
-  Long flashing

Acoustic signals

-  Short
-  Long

USING THE INSTALLATION CARD (optional)

During installation, one or more installation cards can be used. The installation cards are ready for immediate use and do not have to be programmed. With the installation cards, the basic functions (opening and closing) can be carried out on the lock. It is not possible to program user cards with the installation card. The installation card can no longer be used on a lock as soon as the master card has been programmed.

Closing

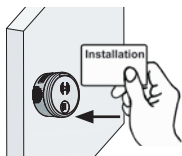

Hold the installation card in front of the lock.



Opening

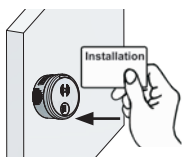

Hold the installation card in front of the lock.



PROGRAMMING THE MASTER CARD

Irrespective of the desired operating mode, a master card must always be programmed before further programming and operation. Only one master card can be programmed per lock! The programming of the master card can be carried out when the lock is closed as well as when it is open. If the lock is closed after the master card has been programmed, the next step must be an emergency opening (see Emergency opening, P. 13).

Programming the master card for the first time

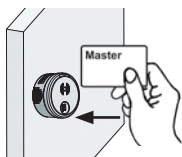







Hold the master card in front of the lock.

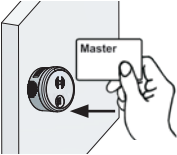

The locking system is in “assigned use” mode after the master card has been programmed. If you would like to use the lock in “shared use” mode, the next thing to do is to change the operating mode. To do this, please follow the instructions on page 12 and then continue with the section “Closing and Opening” on page 12.

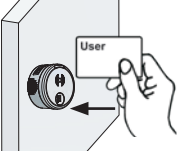

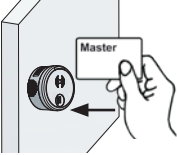

PROGRAMMING THE USER CARDS (only for assigned use mode)

In “assigned use” mode, a maximum of 250 different user cards can be programmed per lock. It is not possible to program user cards in “shared use” mode. In “shared use” mode, the lock can be opened and closed without first programming the user cards (see Closing and Opening, see below).

Programming user cards	
 <p>Hold the master card in front of the lock.</p>	
 <p>Hold the user card in front of the lock. The card is accepted and programmed. This process can be repeated to program multiple user cards.</p> <p>Card is not accepted.</p>	
 <p>Hold the master card in front of the lock.</p>	

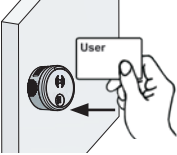
After programming, the user cards can open and close the lock.

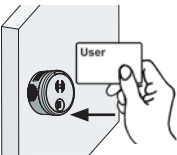
CLOSING AND OPENING

Closing	
 <p>Hold the user card in front of the lock.</p>	
Opening	
 <p>Hold the user card in front of the lock.</p>	

UNAUTHORISED TRANSPONDER CARDS

Rejection of an unauthorised user card

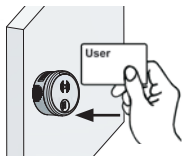

Unauthorised user card is held in front of the lock. The card is rejected.



FACILITY MANAGER FUNCTION

In the event that an authorised person only briefly wants to check whether for example a cabinet is actually occupied, the lock can be opened with the master card. With this function, the lock opens for 30 seconds and then closes automatically. After this automatic closure, authorised user cards can continue to be used in “shared use” mode as well as in “assigned use” mode. The last 5 seconds before closing are indicated by optical and acoustic signals.

Facility Manager Function

(lock closes automatically after 30 seconds)

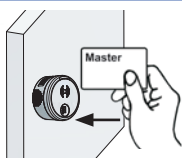

Hold the master card in front of the lock.



EMERGENCY OPENING

In the event that one or all authorised user cards are currently not available, an emergency opening can be effected with the master card. Please note that the lock remains open after emergency opening. In the “shared use” mode, the previously used user card is blocked after emergency opening, and can no longer be used. In “assigned use” mode, user cards can continue to be used normally.

Emergency opening

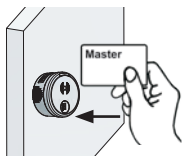

Hold the master card in front of the lock.

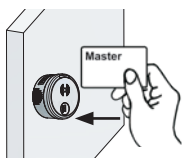







Hold the master card again in front of the lock.

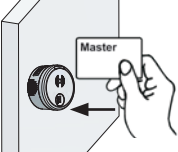

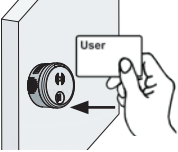
DELETING INDIVIDUAL TRANSPONDER CARDS (only for "assigned use" mode)

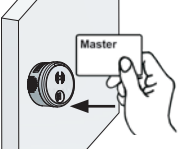

Insofar as further user cards were programmed on the lock, these can continue to be used on this lock after an individual user card has been deleted. For the deleting process, the lock must be open. To do this, first carry out an emergency opening with the master card if necessary (see Emergency opening, P. 13).



Deleting individual user cards	
 <p>Hold the master card in front of the lock.</p>	
 <p>Hold the user card to be deleted in front of the lock.</p>	
 <p>Hold the master card in front of the lock.</p>	

Should the user card be lost, then please proceed as follows.

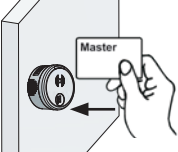
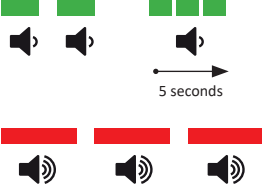
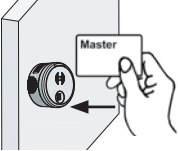
DELETING ALL TRANSPONDER CARDS (only for "assigned use" mode)



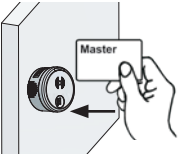



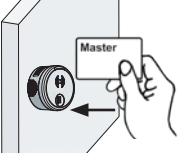

The deleting process can only be carried out when the lock is open. Should there be no authorised user card to hand, first perform an emergency opening using the master card.h.

Deleting all user cards	
 <p>IMPORTANT: Hold the master card in front of the lock until all the following optical and acoustic signals have been received.</p>	
 <p>IMPORTANT: Hold the master card in front of the lock until all the following optical and acoustic signals have been received.</p>	

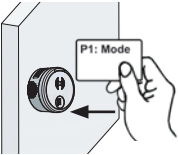
 <p>Hold the master card in front of the lock.</p>	
--	---

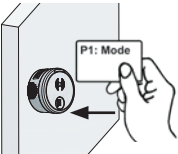
CHANGING THE OPERATING MODE

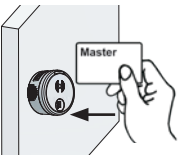





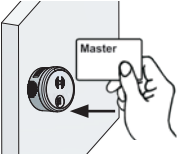

The lock has two modes: “assigned use” and “shared use”. When the lock is open, you have the option of changing the mode. To do this, the master card and the programming card “P1: Mode” are required. The programming card set must be bought separately from LEHMANN Vertriebsgesellschaft mbH & Co. KG. The cards are for universal use.

Changing the operating mode	
 <p>Hold the master card in front of the lock.</p>	
 <p>Hold the programming card “P1: Mode” in front of the lock. “Shared use” mode is selected.</p>	<p>Shared use</p> 
 <p>Hold the programming card “P1: Mode” in front of the lock again. “Assigned use” mode is selected.</p>	<p>Assigned use</p> 
 <p>Hold the master card in front of the lock.</p>	

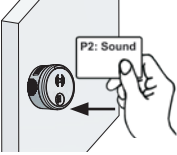
DEACTIVATING AND ACTIVATING ACOUSTIC SIGNALS

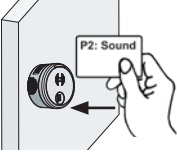
Acoustic signalling is activated when the system is delivered. You have the option of deactivating the acoustic signals with the master card and the programming card “P2: Sound”. The lock must be open.

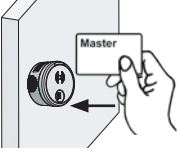



Please note that the acoustic signals for the battery warning and for changing the operating mode cannot be deactivated. The programming card set must be bought separately from LEHMANN Vertriebsgesellschaft mbH & Co. KG. The cards are for universal use.



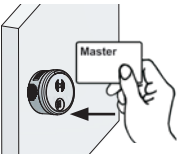

Deactivating and activating acoustic signals	
 <p>Hold the master card in front of the lock.</p>	
 <p>Hold the programming card "P2: Sound" in front of the lock. The acoustic signals are deactivated.</p>	<p>Acoustic signals are deactivated</p> 
 <p>Hold the programming card "P2: Sound" in front of the lock again. The acoustic signals are activated again.</p>	<p>Acoustic signals are activated</p> 
 <p>Hold the master card in front of the lock.</p>	

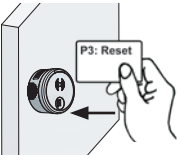
RESETTING TO FACTORY SETTING (Reset)

If a reset to factory settings is required, all master and user cards are deleted. With an installation card the basic functions (close and open) can be carried out. The bolt is retracted, and the lock must be reprogrammed with a master card.

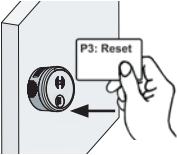

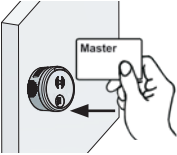



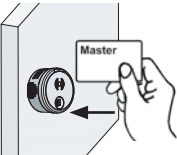

The reset function can be used with the master card and programming card "P3: Reset". For this, the lock must be open. The programming card set must be bought separately from LEHMANN Vertriebsgesellschaft mbH & Co. KG. The cards are for universal use.

Resetting to factory settings	
 <p>Hold the master card in front of the lock.</p>	
 <p>Hold the programming card "P3: Reset" in front of the lock.</p>	

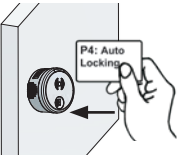
 <p>Hold the programming card "P3: Reset" in front of the lock again.</p>	
 <p>Hold the master card in front of the lock.</p>	 <p>after about 10 seconds</p>

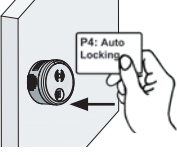
ACTIVATION AND DEACTIVATION OF AUTOMATIC LOCKING

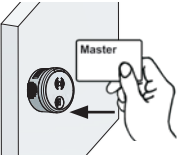
With the programming card "P4: Auto Locking", the function "automatic locking" can be activated and deactivated in the operating mode "assigned use". Once the function is activated, the lock closes automatically after 5 seconds after opening the lock with an authorized transponder. It is recommended to activate "automatic locking" after programming the transponders. The function can be carried out by using the master card and the programming card "P4: Auto Locking". To do this, the lock must be in the mode "assigned use" and in an open position. If the operating mode changes, this function is automatically deactivated. The programming card must be purchased separately from LEHMANN Vertriebsgesellschaft mbH & Co. KG. The card can be used universally.

Activate or deactivate the feature automatic locking	
 <p>Hold the master card in front of the lock.</p>	
 <p>Hold the programming card "P4: Auto Locking" in front of the lock again. Automatic locking is activated.</p>	<p>Automatic locking is activated.</p> 
 <p>Hold the programming card "P4: Auto Locking" in front of the lock again. Automatic locking is deactivated.</p>	<p>Automatic locking is deactivated.</p> 
 <p>Hold the master card in front of the lock.</p>	

ACTIVATION AND DEACTIVATION OF UNLIMITED SHARED USE

With the master card and the „P6: Unlimited Shared Use“ programming card, the function can be activated and deactivated in the „shared use“ mode. After activation, an RFID transponder can lock several locks at the same time (caution: even up to all locks!), instead of just one lock per transponder in this operating mode. To activate and deactivate the function, the lock must be in an open position. The configuration process is the same process as the activation and deactivation of the auto locking function (see page 17).

BATTERY WARNING

The locking system is equipped with a battery management system which uses visual and acoustic signals to indicate the need for battery replacement in the event of reduced battery power. The battery warning takes place in two phases:

Battery warning Phase 1

Before an action can be carried out (closing / opening / programming), a battery warning is given. The batteries should be replaced. The battery warning is also given every 60 minutes



Battery warning Phase 2

The lock can only be opened. Before the lock opens, a battery warning is given. The batteries must be replaced without delay. The battery warning is also given every 60 minutes.



The settings are saved even without a power supply (e.g. in case of battery replacement, or in case the battery should be completely empty). Battery replacement should be carried out within 2 minutes.

REORDERING MASTER CARDS

With this locking system, you have the option of ordering replacements for your master cards at your own expense. For this you obtained a service key together with the master cards. Please keep the service key carefully and securely. The service key makes it possible to reorder the master card specified there. To reorder these cards, please contact LEHMANN Vertriebsgesellschaft mbH & Co. KG at the following email address: sales@lehmann-locks.com

In your email, please give us your contact data and the service key. In your email, please also state the number of replacement cards you require.

FIRMWARE UPDATE

You have the option of updating the firmware of the lock. A special adapter is required for this. Firmware updates for this lock are only made available on the website www.lehmann-locks.com if required (e.g. for technical reasons). You will receive further information on the implementation and installation together with the firmware update.





DISPOSAL

Dispose the locking system in accordance with local regulations and guidelines. Remove the battery and dispose them separately in accordance with the national regulations. When disposing of partially discharged batteries, make sure that there are no short circuits between the battery poles (risk of explosion and fire).

TROUBLE SHOOTING

In the following overview you can see the acoustic and visual signals that indicate faults:

	<p>Transponder card cannot be programmed.</p>	<p>Possible reasons:</p> <ul style="list-style-type: none"> • Storage space is used up • Card is not compatible • Master card has not yet been programmed
	<p>Battery warning Phase 1</p>	<p>It is recommended that you replace the battery.</p>
	<p>Battery warning Phase 2</p>	<p>The battery must be replaced without delay.</p>

LEHMANN Vertriebsgesellschaft mbH & Co. KG
 Postfach 26 20 • D-32383 Minden
 Fon +49 571/50 599-0 • Fax +49 571/50 599-822
info@lehmann-locks.com • www.lehmann-locks.com
 DIN EN ISO 9001:2015 zertifiziert